

# Cascadable Silicon Bipolar MMIC Amplifier

## Technical Data

**MSA-0485**

### Features

- **Cascadable 50 Ω Gain Block**
- **3 dB Bandwidth:**  
DC to 3.6 GHz
- **8.0 dB Typical Gain at  
1.0 GHz**
- **12.5 dBm Typical P<sub>1 dB</sub> at  
1.0 GHz**
- **Unconditionally Stable  
(k>1)**
- **Low Cost Plastic Package**

### Description

The MSA-0485 is a high performance silicon bipolar Monolithic Microwave Integrated Circuit (MMIC) housed in a low cost

plastic package. This MMIC is designed for use as a general purpose 50 Ω gain block. Typical applications include narrow and broad band IF and RF amplifiers in commercial and industrial applications.

The MSA-series is fabricated using HP's 10 GHz  $f_T$ , 25 GHz  $f_{MAX}$ , silicon bipolar MMIC process which uses nitride self-alignment, ion implantation, and gold metallization to achieve excellent performance, uniformity and reliability. The use of an external bias resistor for temperature and current stability also allows bias flexibility.

### 85 Plastic Package

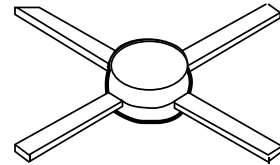

### Typical Biasing Configuration

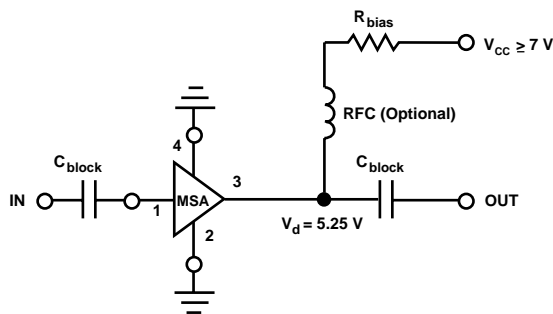

## MSA-0485 Absolute Maximum Ratings

Parameter	Absolute Maximum <sup>[1]</sup>
Device Current	85 mA
Power Dissipation <sup>[2,3]</sup>	500 mW
RF Input Power	+13 dBm
Junction Temperature	150°C
Storage Temperature	-65 to 150°C

**Thermal Resistance<sup>[2,4]</sup>:**

$$\theta_{jc} = 90^{\circ}\text{C/W}$$

### Notes:

1. Permanent damage may occur if any of these limits are exceeded.
2.  $T_{\text{CASE}} = 25^{\circ}\text{C}$ .
3. Derate at 11.1 mW/°C for  $T_{\text{C}} > 105^{\circ}\text{C}$ .
4. See MEASUREMENTS section “Thermal Resistance” for more information.

## Electrical Specifications<sup>[1]</sup>, $T_{\text{A}} = 25^{\circ}\text{C}$

Symbol	Parameters and Test Conditions: $I_{\text{d}} = 50 \text{ mA}$ , $Z_{\text{o}} = 50 \Omega$	Units	Min.	Typ.	Max.
$G_{\text{P}}$	Power Gain ( $ S_{21} ^2$ ) $f = 0.1 \text{ GHz}$ $f = 1.0 \text{ GHz}$	dB	7.0	8.3 8.0	
$\Delta G_{\text{P}}$	Gain Flatness $f = 0.1 \text{ to } 2.5 \text{ GHz}$	dB		$\pm 0.7$	
$f_{3 \text{ dB}}$	3 dB Bandwidth	GHz		3.6	
VSWR	Input VSWR $f = 0.1 \text{ to } 2.5 \text{ GHz}$			1.6:1	
	Output VSWR $f = 0.1 \text{ to } 2.5 \text{ GHz}$			2.0:1	
NF	50 $\Omega$ Noise Figure $f = 1.0 \text{ GHz}$	dB		7.0	
$P_{1 \text{ dB}}$	Output Power at 1 dB Gain Compression $f = 1.0 \text{ GHz}$	dBm		12.5	
$\text{IP}_3$	Third Order Intercept Point $f = 1.0 \text{ GHz}$	dBm		25.5	
$t_{\text{D}}$	Group Delay $f = 1.0 \text{ GHz}$	psec		125	
$V_{\text{d}}$	Device Voltage	V	4.2	5.25	6.3
$\text{dV/dT}$	Device Voltage Temperature Coefficient	mV/°C		-8.0	

### Note:

1. The recommended operating current range for this device is 30 to 70 mA. Typical performance as a function of current is on the following page.

### MSA-0485 Typical Scattering Parameters ( $Z_0 = 50 \Omega$ , $T_A = 25^\circ\text{C}$ , $I_d = 50 \text{ mA}$ )

Freq. GHz	$S_{11}$		$S_{21}$			$S_{12}$			$S_{22}$	
	Mag	Ang	dB	Mag	Ang	dB	Mag	Ang	Mag	Ang
0.1	.21	177	8.4	2.63	175	-16.1	.156	2	.08	-16
0.2	.20	176	8.3	2.60	171	-16.2	.155	2	.08	-30
0.4	.20	172	8.2	2.57	163	-16.1	.156	3	.10	-54
0.6	.19	171	8.1	2.55	155	-16.2	.155	5	.13	-71
0.8	.19	168	8.1	2.54	146	-16.0	.158	6	.16	-83
1.0	.18	166	8.0	2.52	138	-15.7	.164	9	.18	-93
1.5	.16	167	7.8	2.46	117	-15.3	.171	11	.25	-116
2.0	.18	168	7.4	2.34	97	-14.6	.187	12	.29	-136
2.5	.21	173	6.9	2.21	83	-13.8	.204	16	.34	-150
3.0	.27	169	6.3	2.07	65	-13.4	.213	13	.38	-161
3.5	.33	161	5.7	1.92	48	-12.6	.234	9	.39	-172
4.0	.38	154	4.8	1.74	33	-12.3	.242	6	.37	-179
4.5	.42	145	4.1	1.59	18	-12.1	.249	3	.36	-174
5.0	.44	131	3.3	1.46	4	-11.7	.259	-3	.34	-165

A model for this device is available in the DEVICE MODELS section.

### Typical Performance, $T_A = 25^\circ\text{C}$

(unless otherwise noted)

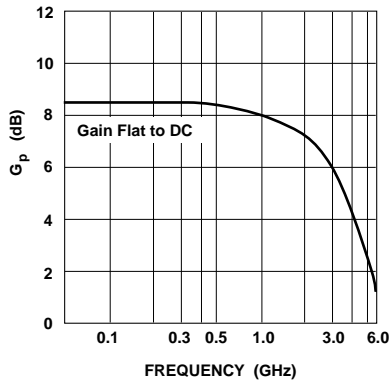

Figure 1. Typical Power Gain vs. Frequency,  $T_A = 25^\circ\text{C}$ ,  $I_d = 50 \text{ mA}$ .

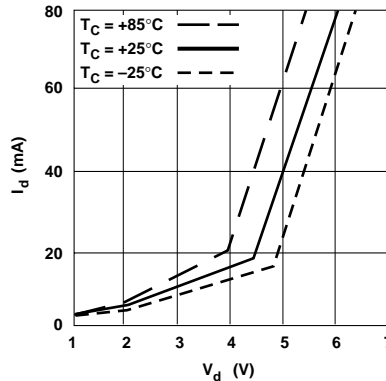

Figure 2. Device Current vs. Voltage.

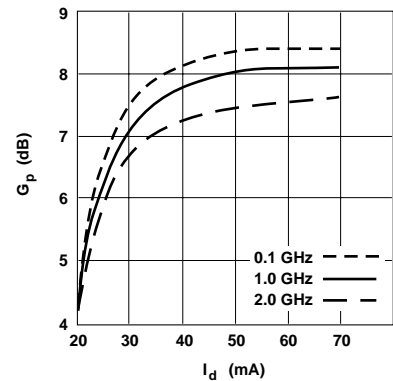

Figure 3. Power Gain vs. Current.

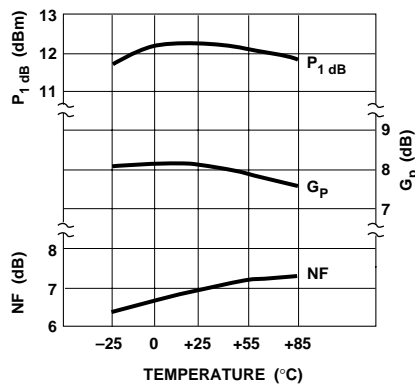

Figure 4. Output Power at 1 dB Gain Compression, NF and Power Gain vs. Case Temperature,  $f = 1.0 \text{ GHz}$ ,  $I_d = 50 \text{ mA}$ .

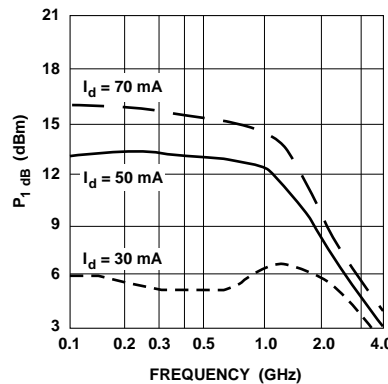

Figure 5. Output Power at 1 dB Gain Compression vs. Frequency.

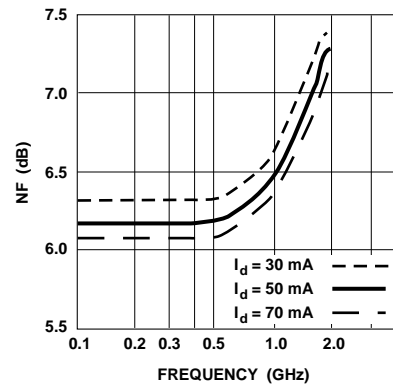

Figure 6. Noise Figure vs. Frequency.

# 85 Plastic Package Dimensions

